

Tapered PTG implant system

Catalog & Surgical Manual

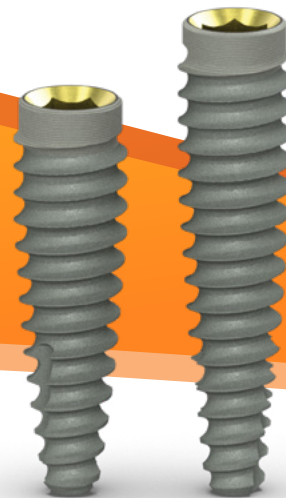

BIOHORIZONS®



BioHorizons Tapered implants

Every implant treatment presents its own challenge. BioHorizons broad portfolio of Tapered implants provides solutions for all indications. Choose from narrow-diameter 3.0mm implants to wide-diameter immediate molar implants or short 6mm-length implants to 18mm-length implants. Whatever your preference, there's a workflow to suit your need, from fully digital to traditional workflows.

guided workflow

BioHorizons guided surgery system uses an open architecture design, providing compatibility with various software providers and guide manufacturers.*



digital restorative workflow

Custom abutments can be sourced through validated milling centers or designed and fabricated in-house.



traditional workflow

BioHorizons comprehensive surgical kit and wide range of prosthetics support traditional workflows.



learn more at biohorizons.com

*Mount-free Tapered Pro, Tapered Internal, Tapered Plus, Tapered 3.0 and Tapered Tissue Level implants

Tapered PTG

Table of contents

Tapered PTG product information & ordering	3-4
surgical instruments	5-9
healing abutments	10
multi-unit abutments	11
instructions for use	12
surgical protocols	13
implant placement level & spacing	14
surgical kit & drill sequence	15
drill overview	16
osteotomy preparation	17
implant transfer	18
healing protocols	19
appendix	20
icon legend	21
ordering, warranty information & references	22



Tapered PTG

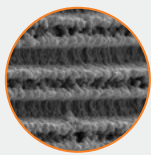
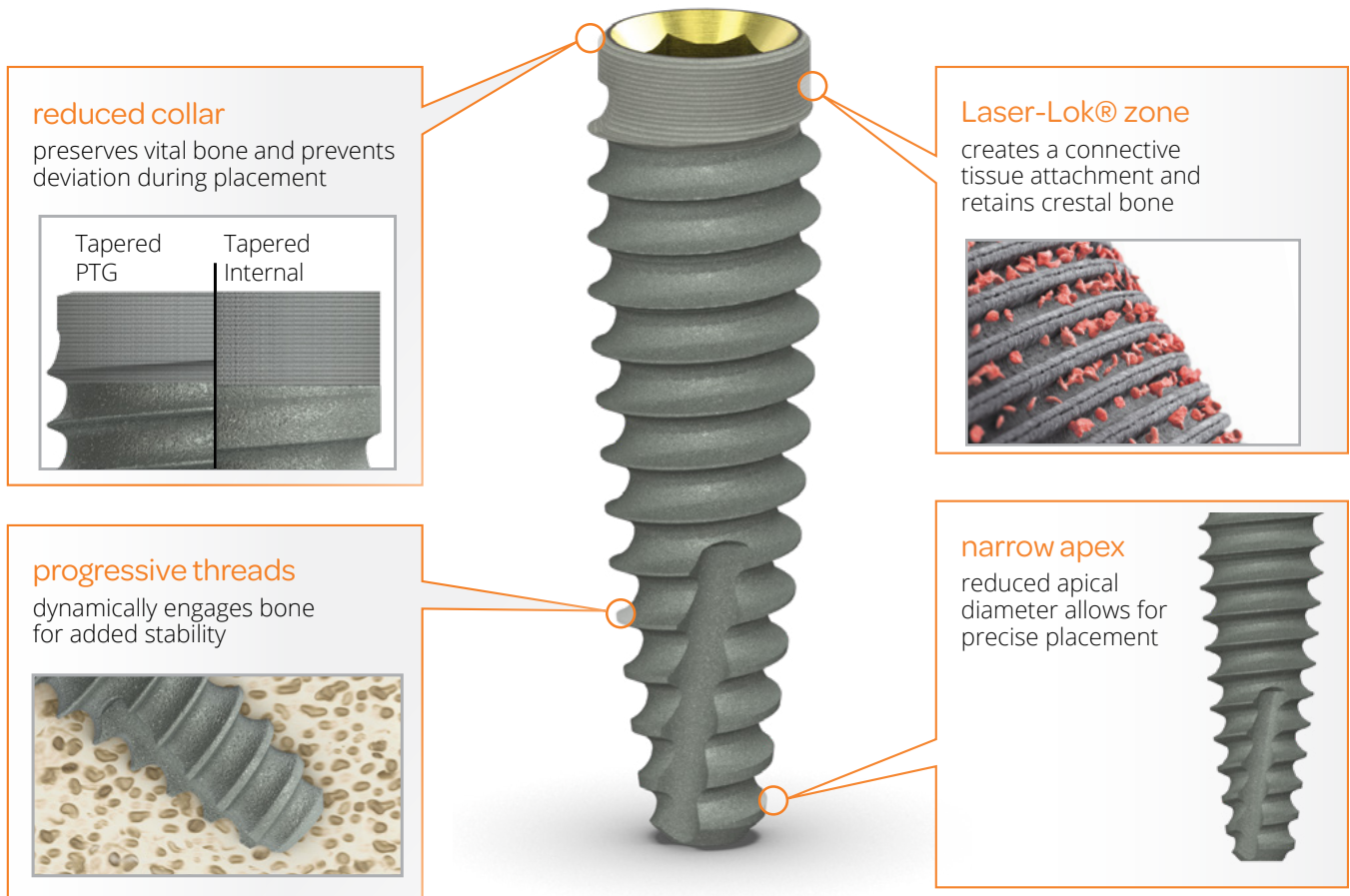

Laser-Lok® microchannels better science, better implants

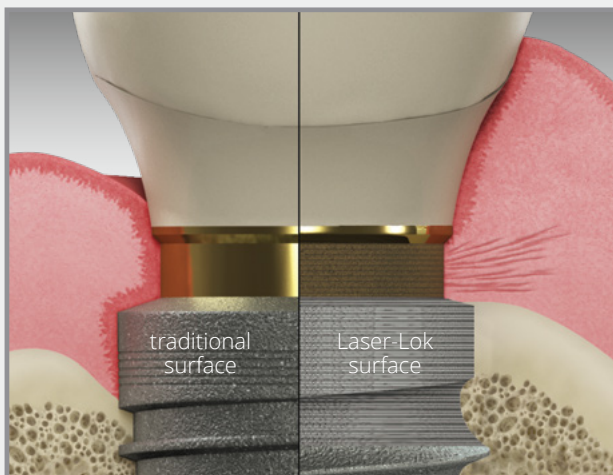

- over 25 years of in vitro, animal and human studies at leading universities¹
- reduced incidence of peri-implantitis compared to traditional surfaces²
- only surface shown to attract a physical, connective tissue attachment³⁻¹¹
- overdenture study showing only 0.42mm of bone loss compared to 1.13mm for NobelReplace™ Select¹²

learn more at
laser-lok.com

Tapered PTG



Tapered PTG implants

BioHorizons Tapered PTG implants support full-arch treatment in severely resorbed maxillae and provide an alternative to grafting, potentially expediting treatment.* Developed in a 4.2mm diameter with 15 and 18mm lengths, the implants feature a unique, dual-tapered body with aggressive buttress threads, suitable for engagement during angled placement in the posterior maxilla. This approach maximizes AP spread for full arch restorations, while maintaining high implant stability. The unique Laser-Lok microchannels create a connective tissue attachment and retain crestal bone, allowing better control of esthetic outcomes.

Part Number	Part Description
PTG4215	Tapered PTG implant, 15mm length
PTG4218	Tapered PTG implant, 18mm length

design features include:

- dual tapered body and aggressive threads provide stability in the pterygomaxillary region
- reduced apical diameter allows for precise placement of the implant apex
- unique Laser-Lok microchannels create connective tissue attachment and retain crestal bone
- osteotomy matched collar preserves vital bone

body diameter	4.2mm
prosthetic connection	3.5mm 
Laser-Lok zone	1.8mm
apical diameter	2.2mm

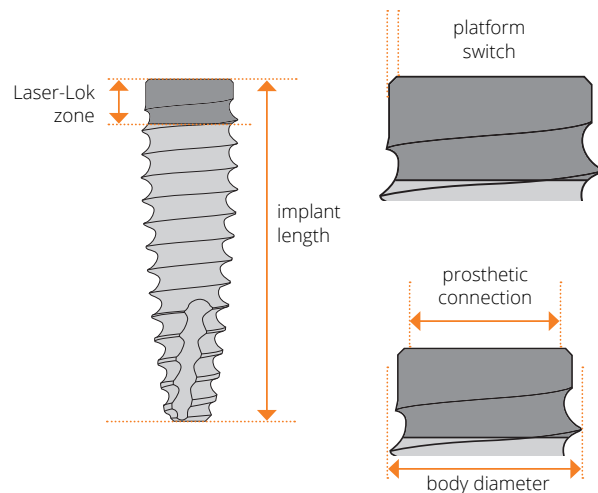

Surgical instruments

Tapered HD Surgical Kit

TSK4000 Tapered HD Surgical Kit

Includes the instrumentation required to place:
Tapered PTG, Tapered Pro, Tapered Internal, Plus, 3.0
and Tissue Level implants.

TSK3500 Tapered HD Surgical Tray (without instruments)

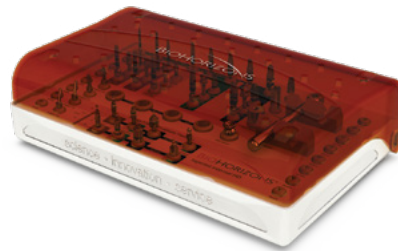
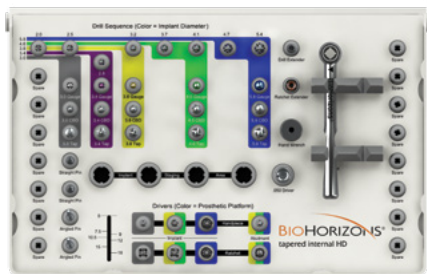
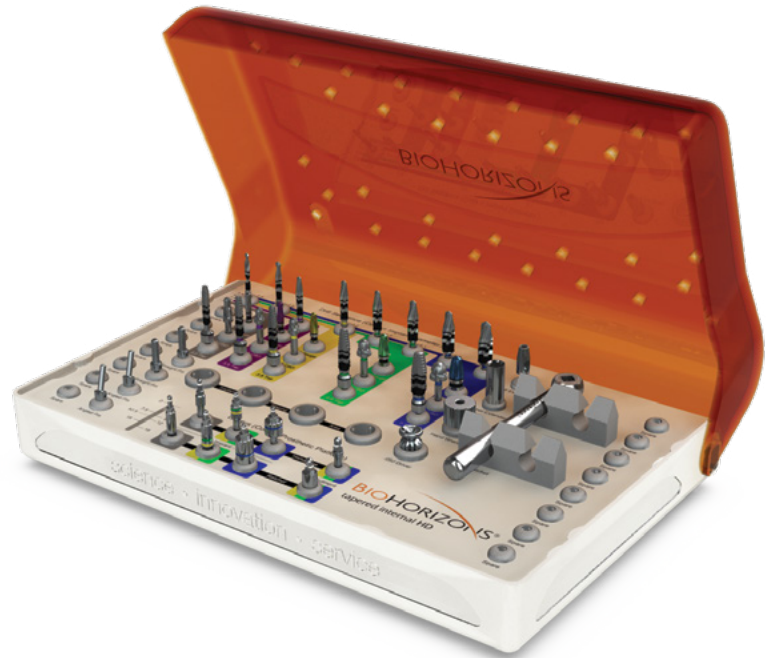

features:

- versatile, removable, hinged lid
- 40% smaller and 40% lighter than other kits
- easy to disassemble and assemble during cleaning
- implant staging area for implant vials during surgery
- use to place Tapered PTG, Tapered Pro, Tapered Internal, Plus, 3.0 and Tissue Level
- empty spare slots for other instrumentation such as stop drills or extended shank drills

Surgical instruments

HD Drills & Bur Block

Tapered HD Drills

The Tapered HD drills feature highly efficient cutting flutes for crisp osteotomies in even the densest bone. Simplified drill markings correspond to the standard implant lengths. Drills should be replaced every 12-20 osteotomies for maximum cutting efficiency.

Part Number	Part Description
TSD2020HD	2.0mm HD Drill
TSD2025HD	2.5mm HD Drill
TSD2028HD	2.8mm HD Drill
TSD2032HD	3.2mm HD Drill
TSD2037HD	3.7mm HD Drill

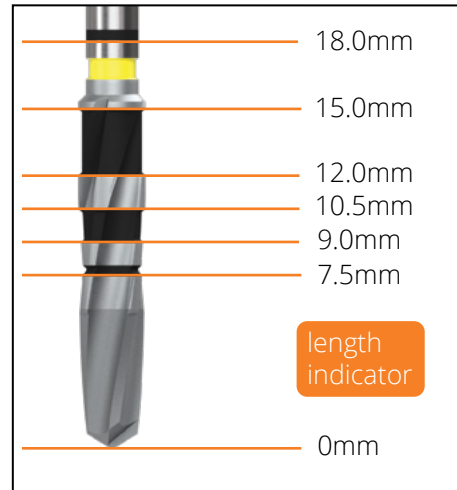

features:

- cutting flutes designed for maximum efficiency
- non-reflective surface for high visibility
- simplified drill markings standard implant lengths
- compatible with Tapered PTG, Tapered Pro, Tapered Internal, Plus, 3.0 and Tissue Level
- creates 12-20 osteotomies depending on bone density
- recommended drill speed 1,500-2,000 rpm (2.0 & 2.5mm), 1,000 rpm (all others)

Extended Shank HD Drills

Extended Shank Drills are 8mm longer than our standard drills.

Part Number	Part Description
TSD4020HD	2.0mm Extended Shank HD Drill
TSD4025HD	2.5mm Extended Shank HD Drill
TSD4028HD	2.8mm Extended Shank HD Drill
TSD4032HD	3.2mm Extended Shank HD Drill
TSD4037HD	3.7mm Extended Shank HD Drill



Surgical instruments

Individual Components



3.5/4.5mm HD Implant-level Drivers

Drivers are color-coded by prosthetic connection:

- 3.0mm platform - no color indicator
- 3.5mm platform - yellow
- 4.5mm platform - green

Part Number	Part Description
TYGIDH	Handpiece Driver
TYGIDR	Ratchet Driver

Parallel Pins



Part Number	Part Description
144-100	Straight Parallel Pins (2 per kit)
144-200	20° Angled Parallel Pins (2 per kit)
144-230	30° Angled Parallel Pins (sold separately)



130-000

Ratchet



135-351

.050" (1.25mm)
Hex Driver



122-100

Drill
Extender



300-205

4mm Square
Drive Extender



300-400

Hand
Wrench

TODKIT2 Tapered Offset Site Dilator Kit

The Tapered Implant site dilators match the geometry of the Tapered surgical drills and are used to create or enlarge osteotomies in soft maxillary bone. These instruments compress the bone laterally rather than removing valuable bone from the surgical site, creating a more dense bone-to-implant interface.

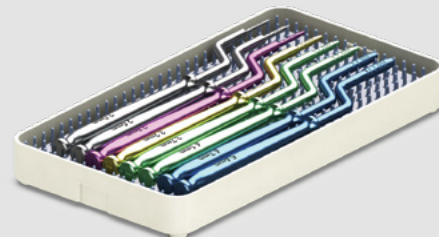

Surgical instruments

Ancillary Instruments



122-015 1.5mm Starter Drill

The 1.5mm starter drill facilitates precise initiation of osteotomies and features a 10.5mm depth marking.



122-110 2.0mm Lindemann Bone Cutter

Side-cutting drill used to correct eccentric osteotomy preparations.



122-106 #6 Round Bur



122-104 Alignment Drill

The alignment drill can be used to initiate the osteotomy to a depth of 5mm. The cutting surface of the drill hub prepares the crestal bone for the depth drill.



DB12 Bur Block

Autoclavable bur block used to store up to 12 instruments.

CGS4000 Guided Surgery Kit (with instruments)

Includes the instrumentation required to place BioHorizons Tapered implants*

Important Note about Guided Surgery Kit

Surgical protocol & guide partners for the CGS4000 can be found at biohorizons.com.



* Mount-free Tapered Pro, Tapered PTG, Tapered Internal, Tapered Plus, Tapered 3.0, Tapered Tissue Level implants. 5.2mm and 5.8mm instruments sold separately.

Surgical instruments

Ancillary Instruments

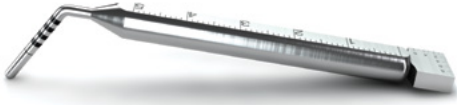

144-300 Implant Spacer / Depth Probe

Use to provide intraoral measurements. Multi-functional tool for marking implant spacing on the ridge and probing osteotomy depth.



PYDBP 3.5mm Deep Bone Profiler

Use at implant uncover to remove excess crestal bone for proper abutment seating. Screw the guide into the implant and align the profiling bur for precise bone removal. Match profiler & guide color to prosthetic connection.

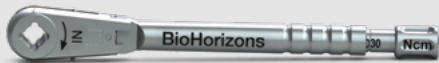

BIOTORQ BioHorizons Adjustable Torque Wrench

Adjustable torque wrench designed to attach to all 4mm drivers from BioHorizons. Supplied with a dual direction mechanism that allows for insertion and removal functions. When the desired torque is reached (a choice of 10Ncm to 30Ncm) the torque wrench snaps to avoid over torquing.

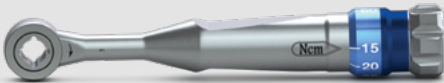

ATW ITL Precise Adjustable Torque Wrench

Place both implants and abutments with 9 distinct torque settings (15, 20, 25, 30, 35, 40, 45, 50 and 60 Ncm). A simple twist of the handle locks in precision-engineered torque values and guarantees accuracy and repeatability.



AGYR-15500 Torque Control 15500

Ergonomic design is the ideal solution for access to screws placed in the posterior. The 7 predetermined torque values (10, 15, 20, 25, 30, 32 and 35 Ncm) make it a tool of extreme precision.



C12374 Elos Adjustable Torque Wrench

Lightweight titanium design is easy to use as a ratchet or adjustable torque wrench with visual indicators for 15, 30, 40, 50, 60, 70, 80 and 90 Ncm. Comes packaged with a 4mm square adaptor. Quickly disassembles for cleaning. No calibration required.



C8521 Elos Replacement Bit, 4mm Square Adapter

C8381 Elos Replacement Bit, Handpiece



Using authentic BioHorizons parts will ensure a precision fit connection between the prosthetic component and implant, avoiding costly component failures that may occur from using third-party prosthetics. Authentic BioHorizons parts are color-coded for easy identification to match the mating implant.

advantages:

- lifetime warranty on all implants and prosthetics
- Spiralock® technology minimizes screw loosening
- precise mating geometries reduce prosthetic failures
- advanced design creates a better engineered connection
- color-coded prosthetic components match implant platforms

Healing Abutments

	Part Description	Abutment diameter	1mm height	2mm height	3mm height	5mm height
Narrow	3.5mm platform	4.0mm	PYNHA1	PYNHA2	PYNHA3	PYNHA5
	3.5mm platform, Laser-Lok	4.0mm	-	-	PYNHA3L	PYNHA5L
Regular	3.5mm platform	4.5mm	-	PYRHA2	PYRHA3	PYRHA5
	3.5mm platform, Laser-Lok	4.5mm	-	-	PYRHA3L	PYRHA5L
Wide	3.5mm platform	6.0mm	-	-	PYWHA3	PYWHA5
	3.5mm platform, Laser-Lok	6.0mm	-	-	PYWHA3L	PYWHA5L

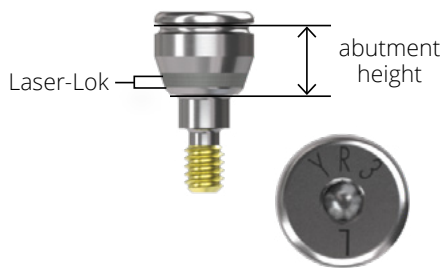

Hand-tighten with the .050" (1.25mm) Hex Driver. Titanium Alloy.

The 3.5mm, 4.5mm and 5.7mm healing abutments are laser marked for easy intraoral identification of the prosthetic platform, emergence and height:

- Y = Yellow (3.5mm) platform
- G = Green (4.5mm) platform
- B = Blue (5.7mm) platform
- N, R or W = Narrow, Regular or Wide emergence
- 1, 2, 3 or 5 = 1mm, 2mm, 3mm or 5mm abutment height
- L = Laser-Lok

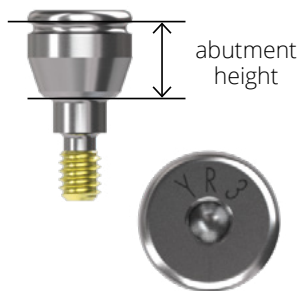

3.0 healing abutments are not laser marked due to their small size.

Use Laser-Lok healing abutments when a Laser-Lok abutment restoration is planned to inhibit epithelial downgrowth, establish a connective tissue attachment and retain crestal bone. When a Laser-Lok component is used and temporarily removed for impression making or other restorative procedures, keep the removed Laser-Lok component in sterile saline until reinserting into the site. Hand-tighten with the .050" (1.25mm) Hex Driver. Titanium Alloy. Note: See L02015-003 Handling of LaserLok Abutments for more information.

Prosthetics

Multi-unit Abutments

Straight Multi-unit Abutments

Straight Multi-unit abutments may be used for multiple-unit restorations including: screw-retained restorations at the abutment level, cast alloy bars for overdentures and fixed/detachable (hybrid) restorations. Comes with a cover cap (PXMUCC). Final torque: 30 Ncm using a Multi-unit Hex Adapter. Titanium alloy.

Part Description	1mm collar	2mm collar	3mm collar	4mm collar	5mm collar
3.5mm platform	PYMU1	PYMU2	PYMU3	PYMU4	PYMU5
3.5mm platform, Laser-Lok	-	PYMU2L	PYMU3L	PYMU4L	-

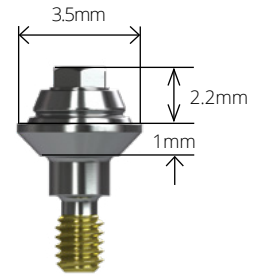

[L02015-003](#) Handling of Laser-Lok abutments module

Angled Multi-unit Abutments

Angled Multi-unit abutments may be used to angle-correct divergent implants. Use for multiple-unit restorations including: screw-retained restorations at the abutment level, cast alloy bars for overdentures and fixed/detachable (hybrid) restorations. Comes with a cover cap (PXMUCC) and abutment screw (PXMUAS). Final torque: 30 Ncm. Titanium alloy. Conveniently deliver abutment one-handed using an .050 hex or Unigrip™ driver or two-handed using an angled Multi-unit carrier (MUCA).

Part Description	2.25mm collar	3mm collar	4mm collar	5mm collar
17° angle, 3.5mm platform	PYMU172	PYMU173	PYMU174	PYMU174
30° angle, 3.5mm platform	-	PYMU303	PYMU304	PYMU305

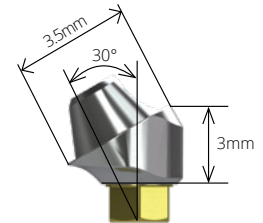
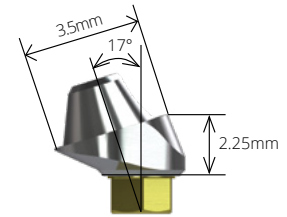

[L02015-028](#) Multi-unit abutment hybrid or fixed-detachable-screw-retained restoration module
[L02015-029](#) Multi-unit abutment bar overdenture - screw-retained restoration module
[L02015-031](#) Correcting a non-passive framework module

Multi-unit Try-in Abutments

Each Try-in is laser marked to correspond with the Multi-unit Abutment collar heights, and can also be used as a measuring tool for OD Secure, Locator, Locator R-Tx and Ball abutment systems. Try-in is carried to the site by the handle and snaps into the implant.

Multi-unit Try-in Abutments may be used to measure tissue thickness and verify proper prosthetic seating prior to final abutment seating.

Part Number	Part Description
TRYPYMU	3.5mm Multi-unit Try-in Straight Abutment
TRYPYMU17	3.5mm Multi-unit Try-in 17° Angled Abutment
TRYPYMU30	3.5mm Multi-unit Try-in 30° Angled Abutment

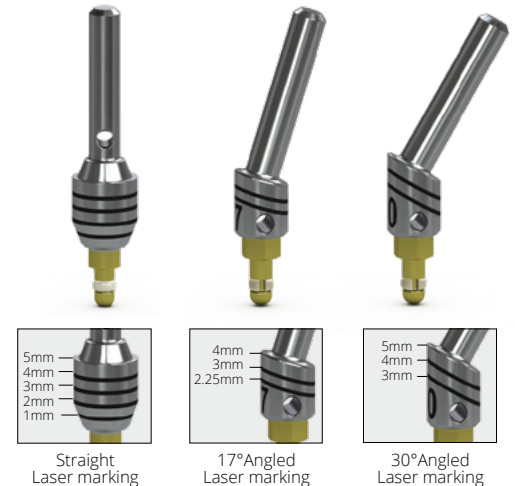

Surgical Manual

Instructions for Use

This surgical manual serves as a reference for using the Tapered PTG implants and surgical instruments. It is intended solely to provide instructions on the use of BioHorizons products. It is not intended to describe the methods or procedures for diagnosis, treatment planning, or placement of implants, nor does it replace clinical training or a clinician's best judgment regarding the needs of each patient. BioHorizons strongly recommends appropriate training as a prerequisite for the placement of implants and associated treatment.

The procedures illustrated and described within this manual reflect idealized patient presentations with adequate bone and soft tissue to accommodate implant placement. No attempt has been made to cover the wide range of actual patient conditions that may adversely affect surgical and prosthetic outcomes. Clinician judgment as related to any specific case must always supersede any recommendations made in this or any BioHorizons literature.



Before beginning any implant surgical procedure with BioHorizons implants:

- Read and understand the Instructions for Use that accompany the products.
- Clean and sterilize the surgical tray and instruments per Instructions for Use.
- Become thoroughly familiar with all instruments and their uses.
- Study surgical kit layout and iconography.
- Design a surgical treatment plan to satisfy the prosthetic requirements of the case.



Small diameter implants are intended for the anterior region of the mouth and are not intended for the posterior region of the mouth due to possible failure of the implant.

Indications

Tapered PTG, Tapered Pro, Tapered Internal, Tapered Plus and Tapered Tissue Level Implants are intended for use in the mandible or maxilla as an artificial root structure for single tooth replacement or for fixed bridgework and dental retention. The implants may be restored immediately:

- 1) with a temporary prosthesis that is not in functional occlusion or
- 2) when splinted together for multiple tooth replacement or when stabilized with an overdenture supported by multiple implants.

Because of their length and diameter, BioHorizons Tapered PTG implants are well-suited for implant placement through the maxillary tuberosity in the pterygoid plate, supporting full-arch treatment in extremely atrophic maxillae and providing an alternative to grafting, which may expedite treatment.^{13,14}

Tapered Internal 3.0 and Tapered Tissue Level 3.0 Implants may be used as an artificial root structure for single tooth replacement of mandibular central and lateral incisors and maxillary lateral incisors. The implants may be restored immediately:

- (1) with a temporary prosthesis that is not in functional occlusion,
- (2) when splinted together as an artificial root structure for multiple tooth replacement of mandibular incisors,
- (3) for denture stabilization using multiple implants in the anterior mandible and maxilla.

The implants may be placed in immediate function when good primary stability has been achieved and with appropriate occlusal loading.

Important Considerations

- Peri-operative oral rinses with a 0.12% Chlorhexidine Digluconate solution have been shown to significantly lower the incidence of post-implantation infectious complications.¹⁵ A pre-operative 30-second rinse is recommended, followed by twice daily rinses for two weeks following surgery.
- Drilling must be done under a constant stream of sterile irrigation. A pumping motion should be employed to prevent over-heating the bone. Surgical drills and taps should be replaced when they are worn, dull, corroded or in any way compromised. BioHorizons recommends replacing drills after 12 to 20 osteotomies.¹⁶ A Drill-usage Tracking Chart is available at biohorizons.com to record this important information.
- There is a risk of injury to the mandibular nerve associated with surgical drilling in posterior mandibular regions. To minimize the risk of nerve injury, it is imperative that the clinician understands the drill depth markings as they relate to the implant length to produce the desired vertical placement of the implant.

Surgical Manual

Surgical Protocols

Two-Stage Protocol

In a two-stage surgery, the implant is placed below the soft tissue and protected from occlusal function and other forces during osseointegration. A low-profile cover cap is placed on the implant to protect it from the ingress of soft tissue.

Following osseointegration, a second procedure exposes the implant and a transmucosal healing abutment is placed to allow for soft tissue healing and development of a sulcus. Prosthetic restoration begins after soft tissue healing.

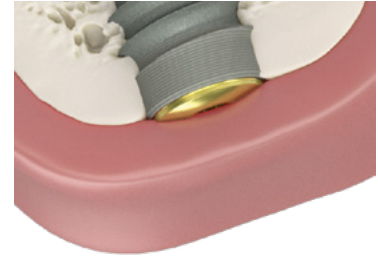

Implant with cover cap in a two-stage protocol.

Single-stage Protocol

Single-stage surgery may be accomplished by placing a healing abutment at the time of implant surgery. This eliminates the need for a second procedure. Although the implant is not in occlusal function, some forces can be transmitted to it through the exposed transmucosal element.

Prosthetic restoration begins following osseointegration of the implant and soft tissue healing.

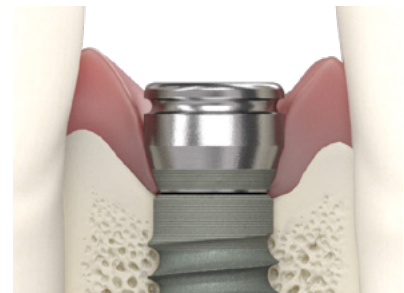

Implant with healing abutment in a single-stage protocol.

Non-functional Immediate Restoration

Single-stage surgery with non-functional immediate provisionalization provides the patient a non-functioning provisional prosthesis early in the treatment plan. An abutment is placed on the implant at or shortly after surgery, and a provisional restoration is secured using temporary cement. The provisional can help contour the soft tissue profile during healing.

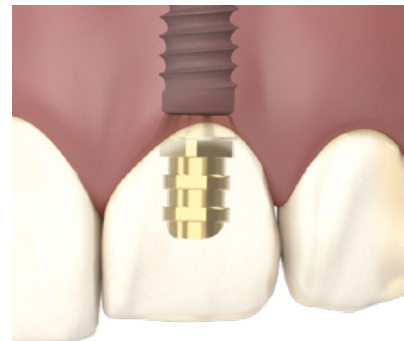

Implant restored with a non-functional provisional prosthesis.

Immediate Function Restoration

Single-stage surgery with immediate function is possible in good quality bone where multiple implants exhibiting excellent initial stability can be splinted together. Splinting implants together may offer a biomechanical advantage over individual, unsplinted prostheses.



Implants with a splinted prosthesis in immediate function.

Surgical Manual

Implant Placement Level & Spacing

Placement in Uneven Ridges

When placing the implant in an uneven ridge, prepare the osteotomy and place the implant so the bone/soft-tissue junction is within the Laser-Lok transition zone. This will allow both soft tissue and bone to attach to the Laser-Lok collar. If the ridge discrepancy is more than the Laser-Lok transition zone, leveling the ridge can be considered.

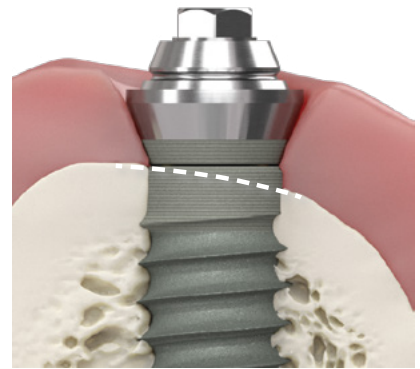

Implant-to-Tooth Spacing

The osteotomy centerpoint required to maintain a specific implant-to-tooth spacing is calculated according to this formula:
 $1/2$ (implant body diameter) + the desired spacing.



During implant placement, clinicians must apply their best judgment as to the appropriate spacing for individual patient conditions.

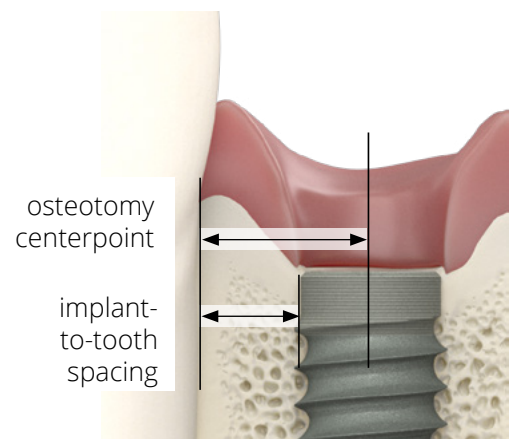

Implant-to-Implant Spacing

The osteotomy center-to-center measurement required to maintain a specific edge-to-edge spacing between two implants is calculated according to this formula: $1/2$ (sum of 2 implant body diameters) + the desired spacing.



During implant placement, clinicians must apply their best judgment as to the appropriate spacing for individual patient conditions.

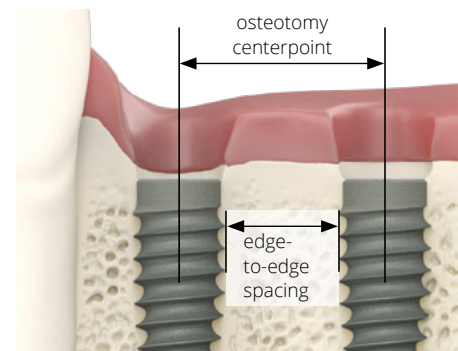

Surgical Manual

Surgical Kit & Drill Sequence

Surgical Kit Instructions

The surgical kit uses an intuitive layout to guide the surgeon through the instrument sequence. The sequence begins in the upper left hand corner and works left-to-right.

Tapered HD drills increase in diameter as you work through the sequence from left-to-right.

Abutment-level drivers are only for mounted implants.



The implant driver section is color-coded by prosthetic platform (gray=3.0mm, yellow=3.5mm, green=4.5mm and blue=5.7mm).

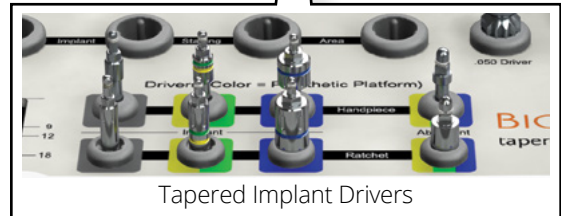
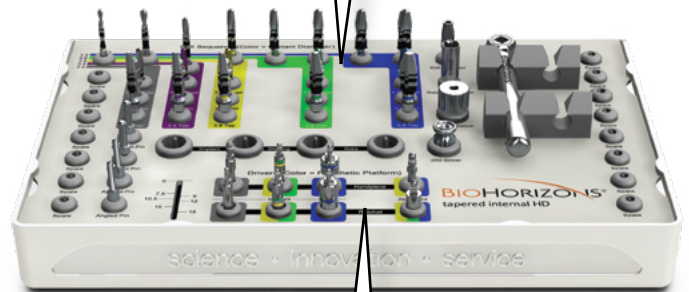
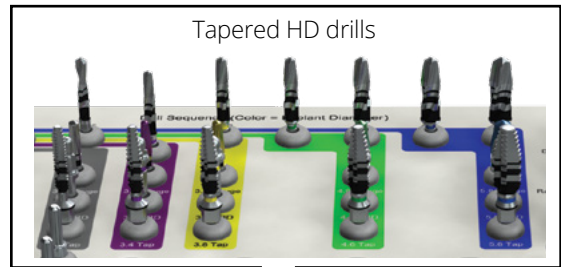

Prior to use, clean and sterilize the surgical tray and instruments according to the Instructions for Use included with the kit. Study the surgical kit layout, color coding and iconography. Surgical assistants should be thoroughly familiar with all instruments and their uses prior to initiating the surgical procedure.



Drill Sequence

The intermediate drill may be used as a final drill in soft bone. The final drill is recommended for use in dense bone.

PTG4215 drill sequence		
TSD4020HD	TSD2032HD	TSD2037HD
15mm depth	12mm depth	12mm depth
		
Starter	Intermediate	Final
Recommended Speed (RPM)		
1,500-2,000	1,000	

PTG4218 drill sequence		
TSD4020HD	TSD2032HD	TSD2037HD
18mm depth	15mm depth	15mm depth
		
Starter	Intermediate	Final
Recommended Speed (RPM)		
1,500-2,000	1,000	

Surgical Manual

Drill Overview

Drill Markings

All surgical drills included with this system are externally irrigated and designed to be used with steady sterile irrigation. Reduced drill speed may be indicated in softer bone or as drill diameter increases.

Note: The depth marks are consistent throughout the starter drills, depth drills and width increasing drills.

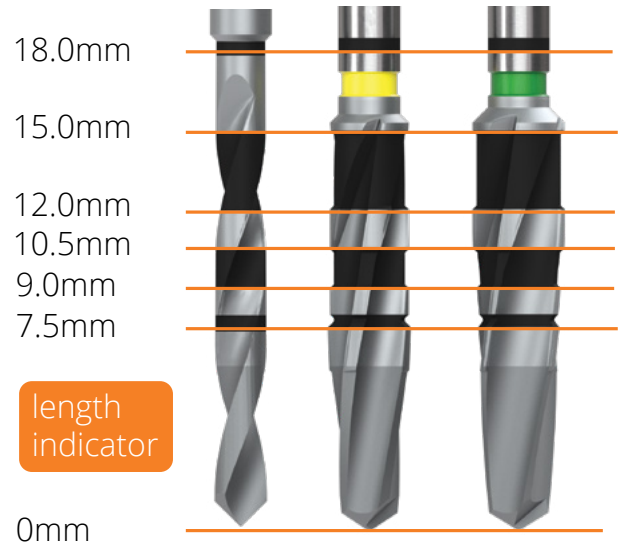

2.0mm HD Drill

The 2.0mm depth drills are designed to increase and/or set the depth of the osteotomy.

An extended shank 2.0 drill is recommended to reach the appropriate depth for 18mm length implants.

2.0mm Starter Drill

Purpose: Initiate osteotomy.

- Chisel-tip design eliminates “skating” on osseous crest
- Prepares site for paralleling pins
- Matte finish for increased visibility under operator lights
- 1,500 - 2,000 RPM



Surgical Manual

Osteotomy Preparation

Paralleling Pins

Purpose: Evaluate osteotomy position and angle.

- Provided straight or with a 20° angle
- Use after 2.0mm Starter Drill
- 9mm shank for radiographic evaluation of proximity to adjacent anatomy
- Hub diameter is 4.0mm

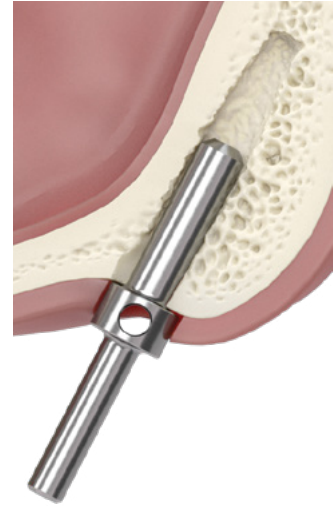

HD Drills

Purpose: Incrementally widen the osteotomy to reduce heat generation.

- Depth-marked for reference
- Efficient cutting drill design collects bone for autografting
- The drill tip has limited end cutting. However, the osteotomy depth can be increased with these drills as needed
- Matte finish for increased visibility under operatory lights
- 1,000 RPM



Implant & Abutment Drivers

Purpose: Engage the implant's internal hex to drive implants into the osteotomy.

- Implant level drivers are color-coded by prosthetic connection: yellow/green=3.5/4.5mm platform
- 30 rpm or less¹⁷

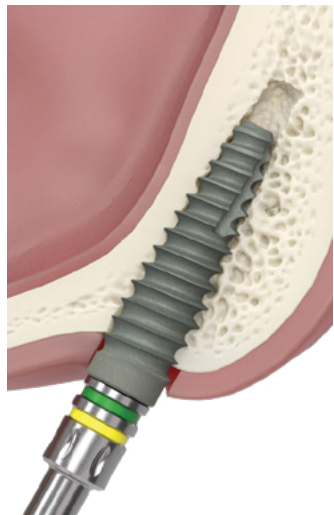

Surgical Manual

Implant Transfer

Implant Pick-up

To pick-up the implant, align the driver hex with the implant hex and press firmly to engage the PEEK snap ring.

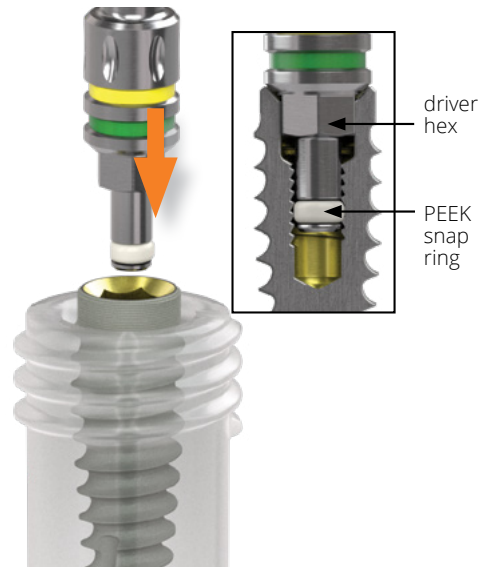

Implant Placement

Place the apex of the implant into the osteotomy and begin rotating slowly.



If too much resistance is felt during insertion, reverse the implant to relieve pressure and re-insert into the osteotomy. If the final drill was not used while preparing the osteotomy, remove the implant and revise the osteotomy with the final drill.

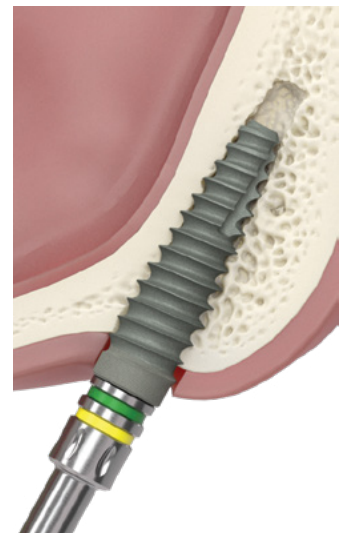

Internal Hex Orientation

When seating the implant, use the corresponding dimples on the driver to orient one internal hex flat perpendicular to the implant angulation plane. Doing so verifies that an angled abutment will correct the angulation.

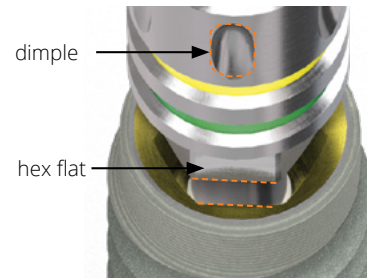
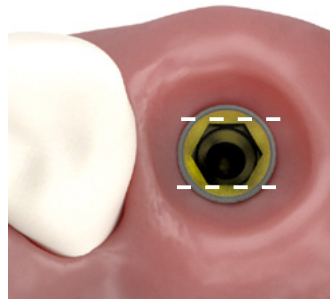

* except 18mm length

Surgical Manual

Healing Protocols

Cover Caps for Two-stage Protocol

Purpose: Protects prosthetic platform in two-stage (submerged) surgical protocol for bone level implants.

- Irrigate implant to remove blood and other debris:
- Use an antibacterial paste to decrease the risk of bacterial growth
- Thread clockwise into implant body
- Color-coded by prosthetic platform
- Hand-tighten (10-15 Ncm) utilizing .050" (1.25mm) Hex Driver

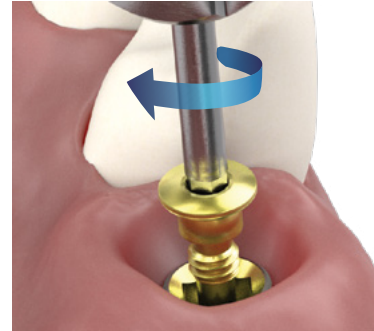

The cover cap for the mount-free implant is mounted in the vial cap.



Healing Abutments for Single-stage Protocol

Purpose: Transmucosal element for developing soft tissue emergence with narrow, regular, wide emergence or Simple Solutions prosthetic components.

- Color-coded by prosthetic platform
- The 3.5, 4.5mm and 5.7mm healing abutments are laser marked for easy intraoral identification; for example: YR3=Yellow (3.5mm) platform / Regular Emergence / 3mm High
- If a Laser-Lok temporary or final restoration is planned, a Laser-Lok healing abutment is required
- Hand-tighten (10-15 Ncm) utilizing .050" (1.25mm) Hex Driver



Immediate Provisional Restorative Options

Temporary Abutments

Purpose: Titanium and PEEK temporaries are easily modified for fabrication of cement or screw-retained provisional restorations. A long direct coping screw (purchased separately) may be used to maintain the screw access hole during the fabrication of a screw-retained provisional prosthesis.



Surgical Manual

Appendix

Bone Profilers

Purpose: In cases where excess crestal bone has been created, use a bone profiler at implant uncover to contour the bone. This will provide the necessary clearance for proper abutment seating.

- Profiler guide protects implant platform
- Color-coded by prosthetic platform
(gray=3.0mm, yellow=3.5mm, green=4.5mm, blue=5.7mm)
- 800 rpm drill speed with steady sterile irrigation



Do not use the profiler without the guide in place.

Using an .050" hex driver, remove the surgical cover cap from the implant and place the profiler guide that matches the color of the prosthetic platform. Use the profiler with copious amounts of sterile irrigation. Once the excess bone and soft tissue are removed, unscrew the guide and seat the appropriate prosthetic component.

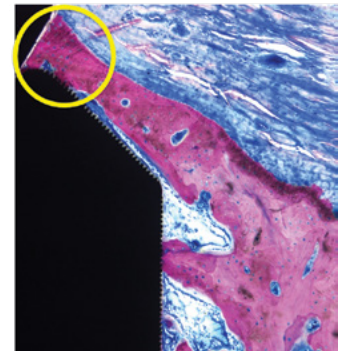
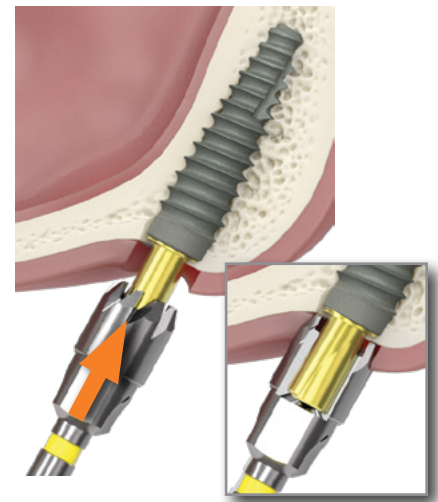

Image showing exceptional bone growth at 3 months.
(Myron Nevins, DDS.)



Post-operative Instructions

A period of unloaded healing time is often recommended to allow for integration between the bone and implant surface. This is dependent on individual patient healing rates and bone quality of the implant site. Each case must be independently evaluated.

The patient should be instructed to follow a post-surgical regimen including cold packs for 24 hours post-implantation. The patient's diet should consist of soft foods and possibly dietary supplements. Pharmacological therapy should be considered as the patient's condition dictates.

If a removable prosthesis is used during the initial healing phase, a soft liner material should be used to prevent pressure on the surgical site. Relieve the prosthesis over the implant site prior to the soft liner application. Periodically check the patient's soft tissue and bone healing using clinical and radiographic evaluations.

Ongoing hygiene for the implant patient is vital. Hygiene recall appointments at three month intervals are suggested. Instruments designed for implant abutment scaling, such as Implacare® instruments from Hu-Friedy® should be utilized. The stainless steel handles may be fitted with assorted tip designs for hygiene on natural teeth. The Implacare® scalers contain no glass or graphite fillers that can scratch titanium implant abutments.

Surgical Manual

Icon Legend

Symbol Descriptions for Product Labeling

REF Reference/article number

LOT Lot/batch number

Use before expiration date (YYYY-MM-DD)

Manufacture date (YYYY-MM-DD)

STERILE IR Sterile by gamma irradiation

NON-STERILE Non-sterile

Label number

do not re-use Single use only

Rx Only Caution: Federal (USA) law restricts these devices to the sale, distribution and use by, or on the order of, a dentist or physician.

CE 2797 BioHorizons products carry the CE mark and fulfill the requirements of the Medical Devices Directive 93/42/EEC

EC REP EU Authorised Representative Quality First International OÜ Laki 30 12915 Tallinn Estonia Tel +372-610-4196

Tapered PTG Product Labeling



body diameter	prosthetic platform
4.2mm	3.5mm (yellow internal hex & cover cap)

ORDERING, WARRANTY INFORMATION AND REFERENCES

BioHorizons Lifetime Warranty on Implants and Prosthetics: All BioHorizons implants and prosthetic components include a Lifetime Warranty. BioHorizons implant or prosthetic components will be replaced if removal of that product is due to failure (excluding normal wear to overdenture attachments).

Additional Warranties: BioHorizons warranties surgical drills, taps and other surgical and restorative instruments.

(1) Surgical Drills and Taps: Surgical drills and taps include a warranty period of ninety (90) days from the date of initial invoice. Surgical instruments should be replaced when they become worn, dull, corroded or in any way compromised. Surgical drills should be replaced after 12 to 20 osteotomies.¹⁶

(2) Instruments: The BioHorizons manufactured instrument warranty extends for a period of one (1) year from the date of initial invoice. Instruments include drivers, implant site dilators and BioHorizons tools used in the placement or restoration of BioHorizons implants.

Return Policy: Product returns require a Return Authorization Form, which may be acquired by contacting Customer Care. The completed Return Authorization Form must be included with the returned product. For more information, please see the reverse side of the invoice that was shipped with the product.

Disclaimer of Liability: BioHorizons products may only be used in conjunction with the associated original components and instruments according to the Instructions for Use (IFU). Use of any non-BioHorizons products in conjunction with BioHorizons products will void any warranty or any other obligation, expressed or implied.

Treatment planning and clinical application of BioHorizons products are the responsibility of each individual clinician. BioHorizons strongly recommends completion of postgraduate dental implant education and adherence to the IFU that accompany each product. BioHorizons is not responsible for incidental or consequential damages or liability relating to use of our products alone or in combination with other products other than replacement or repair under our warranties.

Distributed Products: For information on the manufacturer's warranty of distributed products, please refer to their product packaging. Distributed products are subject to price change without notice.

Validity: Upon its release, this literature supersedes all previously published versions.

Availability: Not all products shown or described in this literature are available in all countries. BioHorizons continually strives to improve its products and therefore reserves the right to improve, modify, change specifications or discontinue products at any time.

Any images depicted in this literature are not to scale, nor are all products depicted. Product descriptions have been modified for presentation purposes. For complete product descriptions and additional information, visit store.biohorizons.com.

References

1. Incidence of Peri-Implant Diseases on Implants with and without Laser-Microgrooved Collar: A 5-Year Retrospective Study Carried Out in Private Practice Patients. Guarnieri R, Grande M, Zuffetti F, Testori T. *Int J Oral Maxillofac Implants*. 2018 Mar/Apr;33(2):457-465.
2. For a complete research summary, please see Laser-Lok Clinical Overview (BioHorizons document ML0606).
3. Human histologic evidence of a connective tissue attachment to a dental implant. M Nevins, ML Nevins, M Camelo, JL Boyesen, DM Kim. *International Journal of Periodontics & Restorative Dentistry*. Vol. 28, No. 2, 2008.
4. The effects of laser microtextured collars upon crestal bone levels of dental implants. S Weiner, J Simon, DS Ehrenberg, B Zweig, JL Ricci. *Implant Dentistry*. Volume 17, Number 2, 2008. p. 217-228.
5. Influence of a microgrooved collar design on soft and hard tissue healing of immediate implantation in fresh extraction sites in dogs. SY Shin, DH Han. *Clin. Oral Impl. Res.* 21, 2010; 804-814.
6. Maintaining inter-implant crestal bone height via a combined platform-switched, Laser-Lok® implant/abutment system: A proof-of-principle canine study. M Nevins, ML Nevins, L Gobbato, HJ Lee, CW Wang, DM Kim. *Int J Periodontics Restorative Dent*. Volume 33, Number 3, 2013.
7. Histologic evidence of a connective tissue attachment to laser microgrooved abutments: A canine study. M Nevins, DM Kim, SH Jun, K Guze, P Schupbach, ML Nevins. *International Journal of Periodontics & Restorative Dentistry*. Vol. 30, No. 3, 2010.
8. Histologic evidence of connective tissue integration on laser microgrooved abutments in humans. NC Geurs, PJ Vassilopoulos, MS Reddy. *Clinical Advances in Periodontics*. Vol. 1, No. 1, May 2011.
9. Connective tissue attachment to laser microgrooved abutments: A human histologic case report. M Nevins, M Camelo, ML Nevins, P Schupbach, DM Kim. *Int J Periodontics Restorative Dent*. Volume 32, Number 4, 2012. p. 384-392.
10. Reattachment of the connective tissue fibers to the laser microgrooved abutment surface. M Nevins, M Camelo, ML Nevins, P Schupbach, DM Kim. *Int J Periodontics Restorative Dent*. Volume 32, Number 4, 2012. e131-134.
11. The impact of dis-/reconnection of laser microgrooved and machined implant abutments on soft- and hard-tissue healing. Ighhaut G, Becker K, Golubovic V, Schliephake H, Mihatovic I. *Clin Oral Implants Res*. 2013 Apr;24(4):391-7.
12. The effects of laser microtexturing of the dental implant collar on crestal bone levels and peri-implant health. S Botos, H Yousef, B Zweig, R Flinton and S Weiner. *Int J Oral Maxillofac Implants*. 2011;26:492-498.
13. Glossary of Oral and Maxillofacial Implants. WR Laney. *Int J Oral Maxillofac Imp*. Jul/Aug 2017;32(4):Gi-G200.
14. Pterygoid implant: option for the rehabilitation of the atrophic posterior maxilla. PVR Nag, P Sarika, T Bhagwatkar, V Dhara. *Int J Contemp Dent Med Rev*. 2019;1-5
15. The influence of 0.12 percent chlorhexidine digluconate rinses on the incidence of infectious complications and implant success. Lambert PM, Morris HF, Ochi S. *J Oral Maxillofac Surg*. 1997;55(12 supplement 5):25-30.
16. Heat production by 3 implant drill systems after repeated drilling and sterilization. Chacon GE, Bower DL, Larsen PE, McGlumphy EA, Beck FM. *J Oral Maxillofac Surg*. 2006 Feb;64(2):265-9.
17. Root Form Surgery in the Edentulous Mandible: Stage I Implant Insertion. CE Misch. *Contemporary Implant Dentistry Second Edition*. Mosby: St. Louis, 1999. 347-369.

Direct Offices

BioHorizons USA
888-246-8338 or 205-967-7880

BioHorizons Canada
866-468-8338

BioHorizons Spain
+34 91 713 10 84

BioHorizons UK
+44 (0)1344 752560

BioHorizons Chile
+56 (2) 23619519

BioHorizons Italy
800-063-040

BioHorizons Mexico
800-953-0498

Distributors

For contact information in our 90 countries, visit biohorizons.com



shop online at
store.biohorizons.com

BioHorizons®, Laser-Lok®, MinerOss®, AutoTac®, Mem-Lok® and TeethXpress® are registered trademarks of BioHorizons. Unigrip™ is a trademark of Nobel Biocare AB. Zimmer® Dental ScrewVent® and Tapered ScrewVent® are registered trademarks of Zimmer, Inc. AlloDerm™, AlloDerm GBR™ and NovoMatrix™ are trademarks of LifeCell Corporation, an Allergan affiliate. Grafton® DBM is a registered trademark of Medtronic, Inc. Cytoplast® is a registered trademark of Osteogenics Biomedical, Inc. Puros Dermis is a registered trademark of Zimmer Biomet. Mucograft is a registered trademark of Ed. Geistlich Sogne AG Fur Chemische Industrie. Symbios PerioDerm is a registered trademark of Dentsply Sirona. Hu-Friedy® is a registered trademark of Hu-Friedy Mfg. Co., LLC. Spiralock® is a registered trademark of Spiralock Corporation. Pomalux® is a registered trademark of Westlake Plastics Co. Locator® is a registered trademark of Zest Anchors, Inc. Delrin® is a registered trademark of E.I. du Pont de Nemours and Company. Bio-Gide® is a registered trademark of Edward Geistlich Sohne AG Fur Chemische Industrie. BioMend® is a registered trademark of Zimmer Biomet Dental. IntraSpin®, L-PRF® and Xpression® are trademarks of Intra-Lock® International Inc. Not all products shown or described in this literature are available in all countries. As applicable, BioHorizons products are cleared for sale in the European Union under the EU Medical Device Directive 93/42/EEC and the tissues and cells Directive 2004/23/EC. We are proud to be registered to ISO 13485:2016, the international quality management system standard for medical devices, which supports and maintains our product licences with Health Canada and in other markets around the globe. Original language is English. ©BioHorizons. All Rights Reserved.



L01077



REV A JUL 2020